

Mini2Plus Mini2Plus Smartphone Modul



Das Smartphone-Modul ist für die Inspektion elektrischer Geräte und die Fehlerbehebung bei HKLS-Problemen ausgelegt. Ausgestattet mit einer funktionalen Wärmebild-App für das Smartphone, ermöglicht das Modul den Blick auf die Wärmebilder direkt auf Ihrem Telefon.

Hauptmerkmale

- Wärmebildauflösung: 256 × 192 (49,152 pixels)
- NETD: < 40 mK (@ 25°C, F#=1.0)
- Messgenauigkeit: ± 2°C (-20°C to 100°C) ; ± 2 % (100°C to 350°C)
- USB Type-C Schnittstelle(Android)
- 24 g Gewicht

▪ Specification

Thermalmodul	
IR-Auflösung	256 × 192 (49,152 pixels)
NETD	< 40 mK (@ 25°C, F#=1.0)
Bildfrequenz	25 Hz
Pixelabstand	12 µm
Spektralempfindlichkeit	7.5 to 14 µm
Brennweite	6.9 mm
Blendenzahl	F1.0
Sichtfeld (FOV)	25° × 18.8°
Minimaler Fokusabstand	0.1 m (0.33 ft)
Fokus-Modus	Manual Focus
Bildanzeige	
Farbpalette	White Hot, Black Hot, Rainbow, Ironbow, Sepia, Color, Ice Fire, Rain, Red Hot, Green Hot, Dark Blue, Combined
Image-Modi	Thermal/Fusion
Messung und Analyse	
Objekttemperaturbereich	-20°C to 350°C (-4°F to 662°F)
Messgenauigkeit	Max. ($\pm 2^\circ\text{C}/3.6^\circ\text{F}$, $\pm 2\%$), for ambient temperature 15°C to 35°C (59°F to 95°F) and object temperature above 0°C (32°F)
Messinstrumente	Center Spot, Hot Spot, Cold Spot User-definable: 3 spots, and 3 rectangles.
Level and Span Mode	Auto/Manual
Allgemein	
Leistungsaufnahme	360 mW
Schutzart	IP40
Falltest Höhe	1 m (3.28 ft)
Betriebstemperaturbereich	-10°C to 50°C (14°F to 122°F)
Speichertemperaturbereich	-20°C to 60°C (-4°F to 140°F)
Gewicht	Approx. 24 g (0.053 lb)
Abmessung	26.6 × 26.6 × 25 mm (1.05 × 1.05 × 0.98 in)

▪ Verfügbares Modell

Mini2Plus

▪ Abmessung

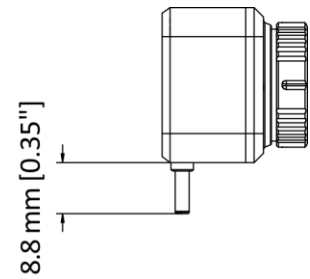
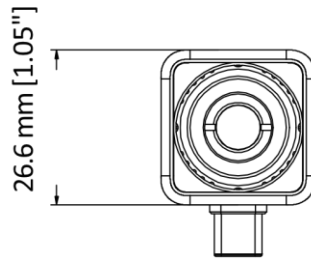
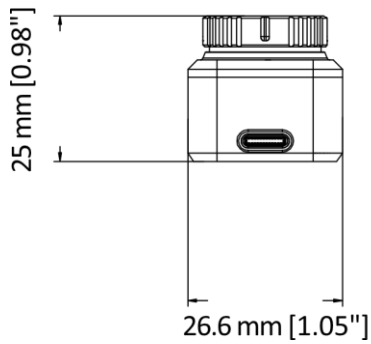

▪ Zubehör

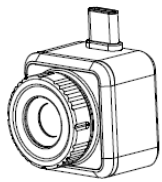

Thermal Module (× 1)

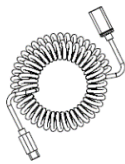

Extension Cord (× 1)



USB Adapter (× 1)

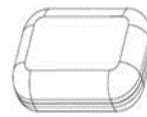

Protective Case (× 1)

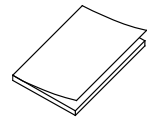

Quick Start Guide (× 1)

COMPLIANCE NOTICE: The thermal series products might be subject to export controls in various countries or regions, including without limitation, the United States, European Union, United Kingdom and/or other member countries of the Wassenaar Arrangement. Please consult your professional legal or compliance expert or local government authorities for any necessary export license requirements if you intend to transfer, export, re-export the thermal series products between different countries.

