



IT8500+

■ Features

- Highlight VFD display
- Dynamic mode: up to 10kHz
- Resolution of voltage and current: 0.1 mV / 0.1 mA
- Four working modes: CV/CC/CR/CP
- Remote sensing function
- Battery test, automatic test, OPP test, OCP test functions. The load will default in the specified mode when turn it on.
- Storage for 100 sets
- Short-circuit function
- Test function
- Current monitoring function
- Power off memory function
- With rotary coding switch to make an easy operation
- Portable strong case equipped with non-slip feet
- Intelligent fans cooling
- Built-in Buzzer function

Single Channel DC Electronic Load

IT8500+ series is a single-channel programmable electronic load. With power ranges from 150W to 3000W. The user can perform online voltage measurements and adjustments or simulate short circuit test using the simple keypad on the front panel. It also offers a full-featured battery mode for discharging test. IT8500+ series DC loads are a versatile instrument for static and dynamic testing of power supplies, batteries, DC-DC converters, battery chargers, provides user the best testing solution.

Constant Current (CC)

In CC mode, the electronic load will sink a constant current regardless of the changes of input voltage.

Constant Voltage (CV)

In CV mode, the electronic load will attempt to sink enough current to control the source voltage to the programmed value.

Constant Resistance (CR)

In CR mode, the module will sink a current linearly proportional to the input voltage in accordance with the programmed resistance.

Constant Power (CP)

In CP mode, the electronic load will dissipate power in accordance with the programmed value. If input voltage increase, input current will decrease.

Model	Voltage	Current	Power
IT8511A+	150 V	30 A	150W
IT8512A+	150 V	30 A	300W
IT8512B+	500V	15 A	300W
IT8512C+	120 V	60 A	300W
IT8512H+	800 V	5A	300 W
IT8513C+	120 V	120 A	600W
IT8514B+	500 V	60 A	1500W
IT8514C+	120 V	240 A	1500W
IT8516C+	120 V	240 A	3000W

*Note: IT8514C+ and IT8516C+ have RS232 and USB interface

Transient Mode

Transient operation enables the module to periodically switch between two load levels, as might be required for testing power supplies. Transient operation can be turned on and off from the front panel (shift + numeric key "2"). Before you turn on the operation, you should set the parameters associated with the transient operation. The parameters include: A level, B level, frequency, duty cycle and transient testing modes. There are three different transient testing modes: continuous, pulse, and toggle.

■ Continuous Mode

In continuous mode, the electronic load generates a repetitive pulse stream that toggles between two load levels. Load could switch the state between two value settings, A/B.

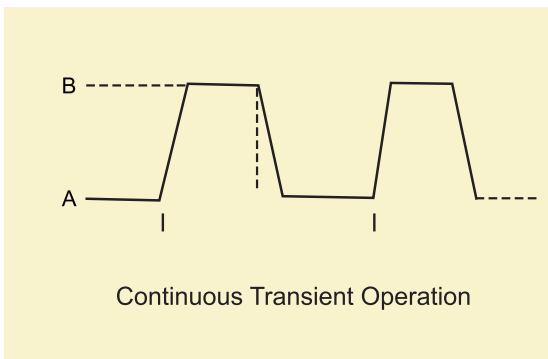

■ Pulse Mode

In pulse mode, the electronic load generates a transient pulse of programmable width when pulse transient operation is in effect. The load will automatically switch to A level after maintaining A width time. Then it will switch to B level. The load will not switch to A level again until the instrument receives the pulse signal.

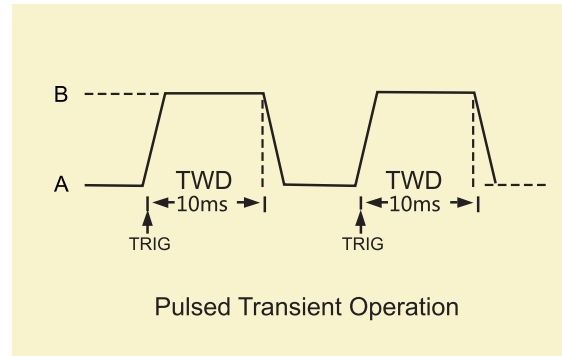

■ Toggle Mode

In toggle mode, the electronic load will switch between A level and B level when receiving a trigger signal after the transient operation is enabled. The following picture shows the current waveform in toggle transient operation.

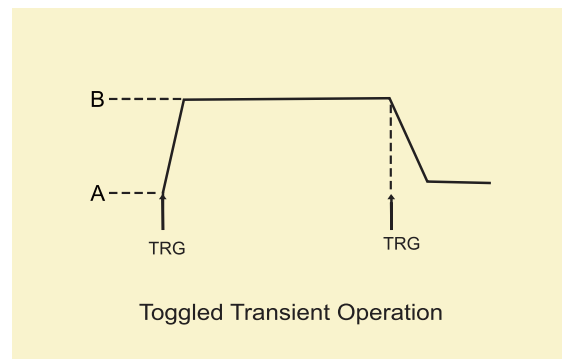

Automatic Test Function

The automatic test function of the IT8500+ series electronic load is useful for simulating various tests and allows the user to edit up to 10 groups of testing files. Each file has 10 steps and up to 100 files can be edited and saved into the EEPROM.

User can also set the default power-up mode to be automatic test. It improves the productivity and automatically judge the product quality.

Test steps	Test methods				Ripple wave range
	Mode	Voltage range (V)	Current range (mA)	Power(W)	
Step 1	CC	5.8-6.15	210	<4	<50mVpp
Step 2	no-load	5.9-6.4	0	<1.2	
Step 3	short circuit	0	<245		
Step 4	CV	5	205-245		

List Mode

List mode allows you to generate a complex current sequence. Moreover, the mode change can be synchronized with an internal or external signal, to accomplish dynamic and precise test which can save cost for users.

Users can edit step value, pulse width and slope sequence and meet a complex test request. A list file includes following parameters: file name step counts (range 2-84), time width of single step (0.00002s-3600s), step value and slope. The edited list file can be recalled easily. The DC load provides 7 nonvolatile registers to save list files setting for recall later. In the list mode, the DC start to run the list file once receiving a trigger signal, continue to run until end of the operation or receiving another trigger.

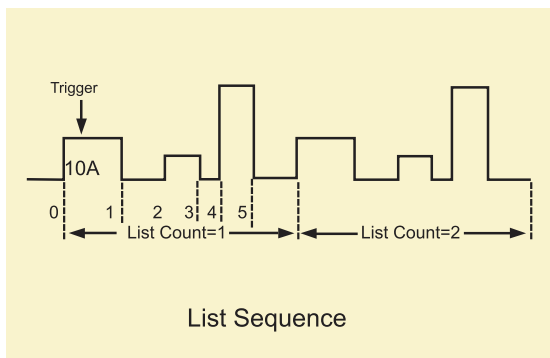

Remote Sense

When working in CC, CV, CP and CR mode, if the electronic load consumes a very large current, it will cause a voltage drop in the leads between the connected device and terminals of the electronic load. In order to ensure testing accuracy, the electronic load provides a pair of remote sensing terminals in the rear panel where users can sense the output terminal voltage of the connected device. Users should set the electronic load in REMOTE SENSE mode before using this function. By eliminating the effect of the voltage drop in the load leads, remote sensing provides greater accuracy by allowing the electronic load to regulate directly at the source's output terminals.

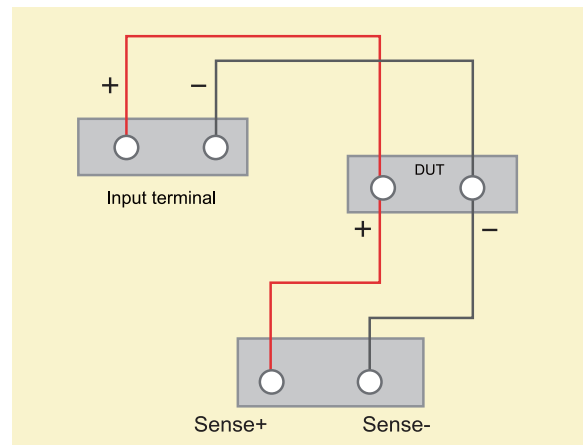

Battery Mode

A battery test mode is provided that will measure the ampere*hour (A*hr) characteristic of a battery. It measures the time it takes for a battery voltage to drop to a specified value while drawing a constant current from the battery.

There are three stop conditions for IT8500+ series loads: Time, capacity and voltage. In addition, user can make any combination of stop conditions to achieve "And", "Or" relationship. When one or more stop conditions are satisfied, the test is ended and the discharging time, capacity in ampere*hours (A*hrs) of the battery is calculated and displayed on the front panel.

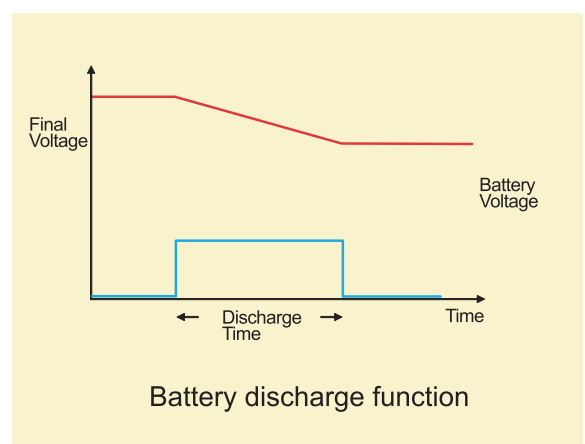

Battery discharge function



IT8511+ / IT8512+ / IT8512B+ Specification

		IT8511+		IT8512+		IT8512B+	
Input Rating	Voltage	0 ~ 120 V		0 ~ 120 V		0 ~ 500 V	
	Current	0 ~ 3 A	0 ~ 30 A	0 ~ 3 A	0 ~ 30 A	0 ~ 3 A	0 ~ 15 A
(0~40°C)	Power	150 W		300 W		300 W	
	Minimum operating voltage	0.14V at 3A	1.4V at 30A	0.12V at 3A	1.2V at 30A	0.6V at 3A	3V at 15A
CV Mode	Range	0 ~ 18 V	0 ~ 120 V	0 ~ 18 V	0 ~ 120 V	0 ~ 50 V	0 ~ 500 V
	Resolution	1 mV	10 mV	1 mV	10 mV	1 mV	10 mV
	Accuracy	± (0.05%+0.02%FS)	± (0.05%+0.025%FS)	± (0.05%+0.02%FS)	± (0.05%+0.025%FS)	± (0.05%+0.02%FS)	± (0.05%+0.025%FS)
CC Mode	Range	0 ~ 3 A	0 ~ 30 A	0 ~ 3 A	0 ~ 30 A	0 ~ 3 A	0 ~ 15 A
	Resolution	0.1 mA	1 mA	0.1 mA	1 mA	0.1 mA	1 mA
	Accuracy	± (0.05%+0.05%FS)					
CR Mode	Range	0.05 Ω ~ 10 Ω	10 Ω ~ 7.5 KΩ	0.05 Ω ~ 10 Ω	10 Ω ~ 7.5 KΩ	0.3 Ω ~ 10 Ω	10 Ω ~ 7.5 KΩ
	Resolution	16bit					
	Accuracy	0.01%+0.08S	0.01%+0.0008S	0.01%+0.08S	0.01%+0.0008S	0.01%+0.08S	0.01%+0.0008S
CP Mode	Range	150 W		300 W		300 W	
	Resolution	10m W					
	Accuracy	0.1 % + 0.1 % FS		0.1 % + 0.1 % FS		0.1 % + 0.1 % FS	
		CC mode		CC mode		CC mode	
Dynamic Mode	T1 & T2	50 μS~3600 S / Res:1μS					
	Accuracy	5 μS ± 100 ppm					
	Rising / Falling Slope	0.0001~0.3A/μS	0.001~1.5A/μS	0.0001~0.3A/μS	0.001~1.5A/μS	0.0001~0.3A/μS	0.001~0.8A/μS
		Measurement range					
V Measurement	Range	0 ~ 18 V	0 ~ 120 V	0 ~ 18 V	0 ~ 120 V	0 ~ 50 V	0 ~ 500 V
	Resolution	0.1 mV	1 mV	0.1 mV	1 mV	1 mV	10 mV
	Accuracy	± (0.025 % + 0.025 % FS)					
C Measurement	Range	0 ~ 3 A	0 ~ 30 A	0 ~ 3 A	0 ~ 30 A	0 ~ 3 A	0 ~ 15 A
	Resolution	0.1 mA	1 mA	0.1 mA	1 mA	0.1 mA	1 mA
	Accuracy	± (0.05 % + 0.05 % FS)					
P Measurement	Range	150 W		300 W		300 W	
	Resolution	10 mW					
	Accuracy	± (0.1 % + 0.1 % FS)		± (0.1 % + 0.1 % FS)		± (0.1 % + 0.1 % FS)	
		Protection range					
	Over power protection	≈160 W		≈320 W		≈320 W	
	Over current protection	≈3.3 A	≈33 A	≈3.3 A	≈33 A	≈3.3 A	≈16 A
	Over voltage protection	≈125 V				≈530 V	
	Over temperature protection	≈85 °C				≈85 °C	
		Specification					
Short Circuit	Current(CC)	≈3.3 / 3 A	≈33 / 30 A	≈3.3 / 3 A	≈33 / 30 A	≈3.3 / 3 A	≈16 / 15 A
	Voltage(CV)	0V					
	Resistance(CR)	≈45 mΩ		≈40 mΩ		≈180 mΩ	
	Input impedance	150 KΩ					
Dimension (W*D*H)		214.5 mm * 354.6 mm * 88.2 mm				214.5 mm * 354.6 mm * 88.2 mm	

IT8511A+ / IT8511B+ / IT8512B+ / IT8512C+ / IT8512 + / IT8513C+

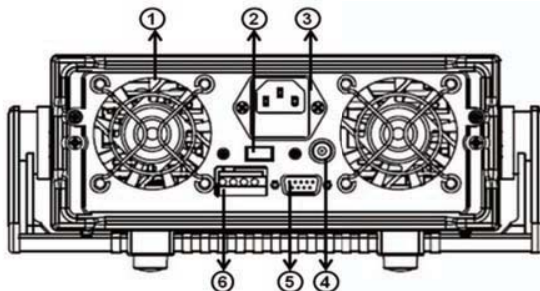

- ① Air vents
- ② Voltage switch (110V/220V)
- ③ AC line input
- ④ Current monitoring Terminal
- ⑤ -Pin serial port interface connector
- ⑥ Trigger and remote sensing terminal block

IT8512C+ / IT8513C+ / IT8514C+ Specification

		IT8512C+		IT8513C+		IT8514C+	
Input Rating	Voltage	0 ~ 120 V		0 ~ 120V		0 ~ 120 V	
	Current	0 ~ 6 A	0 ~ 60 A	0 ~ 12 A	0 ~ 120 A	0 ~ 24 A	0 ~ 240 A
(0~40°C)	Power	300 W		600 W		1500 W	
	Minimum operating voltage	0.25V at 6A	2.5V at 60A	0.2V at 12A	2V at 120A	0.25V at 24A	2.5V at 240A
CV Mode	Range	0 ~ 18 V	0 ~ 120 V	0 ~ 18 V	0 ~ 120 V	0 ~ 18 V	0 ~ 120 V
	Resolution	1 mV	10 mV	1 mV	10 mV	1 mV	10 mV
	Accuracy	± (0.05%+0.02%FS)		± (0.05%+0.02%FS) ± (0.05%+0.025%FS)		± (0.05%+0.02%FS) ± (0.05%+0.025%FS)	
CC Mode	Range	0 ~ 6 A	0 ~ 60 A	0 ~ 12 A	0 ~ 120 A	0 ~ 24 A	0 ~ 240 A
	Resolution	0.1 mA	1 mA	1 mA	10 mA	1 mA	10 mA
	Accuracy	±(0.05%+0.05%FS)					
CR Mode	Range	0.05 Ω ~ 10 Ω	10 Ω ~ 7.5 KΩ	0.05 Ω ~ 10 Ω	10 Ω ~ 7.5 KΩ	0.05 Ω ~ 10 Ω	10 Ω ~ 7.5 KΩ
	Resolution	16bit					
	Accuracy	0.01%+0.08S	0.01%+0.0008S	0.01%+0.08S	0.01%+0.0008S	0.01%+0.08S	0.01%+0.0008S
CP Mode	Range	300 W		600 W		1500 W	
	Resolution	10 mW		10 mW		10 mW	
	Accuracy	0.1% + 0.1% FS		0.2% + 0.2% FS		0.2% + 0.2% FS	
Dynamic mode							
CC mode							
Dynamic Mode	T1 & T2	20 μS~3600 S / Res:1 μS		100μS~3600S / Res:1 μS		100μS~3600S / Res:1 μS	
	Accuracy	2 μS ± 100 ppm		10 μS ± 100 ppm		10 μS ± 100 ppm	
	Rising / Falling Slope	0.0001~0.3 A / μS	0.001~3A / μS	0.001~0.2A / μS	0.01~1.6A / μS	0.001~0.3A / μS	0.01~3.2A / μS
Measurement range							
V Measurement	Range	0 ~ 18 V	0 ~ 120 V	0 ~ 18 V	0 ~ 120 V	0 ~ 18 V	0 ~ 120 V
	Resolution	1 mV	10 mV	0.1 mV	1 mV	0.1 mV	1 mV
	Accuracy	± (0.025% + 0.025% FS)		± (0.025% + 0.025% FS)		± (0.025% + 0.025% FS)	
C Measurement	Range	0 ~ 6 A	0 ~ 60 A	0 ~ 12 A	0 ~ 120 A	0 ~ 24 A	0 ~ 240 A
	Resolution	0.1 mA	1 mA	1 mA	10 mA	1 mA	10 mA
	Accuracy	± (0.05% + 0.05%FS)		± (0.05% + 0.05%FS)		± (0.05% + 0.05%FS)	
P Measurement	Range	300 W		600 W		1500 W	
	Resolution	10 mW		10 mW		10 mW	
	Accuracy	± (0.1% + 0.1% FS)		± (0.2% + 0.2% FS)		± (0.2% + 0.2% FS)	
Protection range							
	Over power protection	≈320 W		≈620 W		≈1500 W	
	Over current protection	≈6.5 A	≈65 A	≈13 A	≈130 A	≈26.7 A	≈267 A
	Over voltage protection	≈85 °C		≈125V ≈95 °C		≈85 °C	
	Over temperature protection	≈85 °C					
Specification							
Short Circuit	Current(CC)	≈6.5/6 A	≈65/60 A	≈13/12 A	≈130/120 A	≈26.7/24 A	≈267/240 A
	Voltage(CV)	0V					
	Resistance(CR)	≈40 mΩ		≈15 mΩ		≈8 mΩ	
	Input impedance	150KΩ					
Dimension (W*D*H)		214.5 mm * 354.6 mm * 88.2 mm		482.7mm * 131.4mm * 536mm		436.5 mm * 463.5 mm * 88.2 mm	

IT8511A+ / IT8512A+ / IT8512 + Specification

		IT8511A+		IT8512A+		IT8512 +	
Input Rating	Voltage	0 150 V		0 150 V		0 800 V	
	Current	0 3 A	0 30 A	0 3 A	0 30 A	0 1 A	0 5 A
(0~40°C)	Power	150 W		300 W		300 W	
	Minimum operating voltage	0.3 V at 3 A	3 V at 30 A	0.14 V at 3 A	1.4V at 30 A	1.4 V at 1 A	7 V at 5 A
CV Mode	Range	0.1 18 V	0.1 150 V	0 18 V	0 150 V	0 80 V	0 800 V
	Resolution	1 mV	10 mV	1 mV	10 mV	1 mV	10 mV
	Accuracy	(0.05 +0.025 FS)		(0.05 +0.02 FS)		(0.05 +0.025 FS)	
CC Mode	Range	0 3 A	0 30 A	0 3 A	0 30 A	0 1 A	0 5 A
	Resolution	0.1 mA	1 mA	0.1 mA	1 mA	0.1 mA	1 mA
	Accuracy	(0.05 +0.05 FS)		(0.05 +0.05 FS)		(0.05 +0.1 FS)	
CR*1 Mode	Range	0.1Ω~10Ω	10Ω~7.5 KΩ	0.05Ω~10Ω	10Ω~7.5 KΩ	2Ω~10Ω	10Ω~7.5 KΩ
	Resolution	16 bit		16 bit		16 bit	
	Accuracy	0.01 +0.08 S ²	0.01 +0.0008 S	0.01 +0.08 S	0.01 +0.0008 S	0.01 +0.08 S	0.01 +0.0008 S
CP*1 Mode	Range	150 W		300 W		300 W	
	Resolution	10 mW		10 mW		10 mW	
	Accuracy	0.2 +0.2 FS		(0.1 +0.1 FS)		0.2 +0.2 FS	
Dynamic mode							
CC mode							
Dynamic Mode	T1 & T2	20μS~3600 S/ Res:1μS		20μS~3600 S/ Res:1μS		20μS~3600 S/ Res:1μS	
	Accuracy	2μS+100 ppm		2μS+100 ppm		2μS+100 ppm	
	Rising/falling slope *3	0.0001~0.12 A/μS		0.0001~0.2 A/μS	0.001~1.5 A/μS	0.0001~0.04 A/μS	0.001~0.2 A/μS
	Minimum rising time *4	≈20μS	≈30μS				
Measurement range							
V Measurement	Range	0 18 V	0 150 V	0 18 V	0 150 V	0 80 V	0 800 V
	Resolution	0.1m V	1m V	0.1m V	1m V	1m V	10m V
	Accuracy	(0.05 +0.025 FS)		(0.025 +0.025 FS)		(0.025 +0.025 FS)	
C Measurement	Range	0 3 A	0 30 A	0 3 A	0 30 A	0 1 A	0 5 A
	Resolution	0.1 mA	1 mA	0.1 mA	1 mA	0.1 mA	1 mA
	Accuracy	(0.05 +0.05 FS)		(0.05 +0.05 FS)		(0.05 +0.05 FS)	
P Measurement	Range	150W		300W		300W	
	Resolution	10mW		10mW		10mW	
	Accuracy	(0.2 +0.2 FS)		(0.1 +0.1 FS)		(0.2 +0.2 FS)	
Protection							
	OPP	≈160W		≈320W		≈320W	
	OCP	≈3.3 A	≈3.3 A	≈3.3 A	≈33 A	≈1.1 A	≈5.5 A
	OVP	≈160 V		≈160 V		≈850 V	
	OTP	≈85 °C		≈85 °C		≈85 °C	
Specification							
Short Circuit	Current(CC)	≈3.3/3A	≈33/30A	≈3.3/3A	≈33/30A	≈1.1/1A	≈5.5/5A
	Voltage(CV)	0 V					
	Resistance(CR)	≈100 mΩ		≈40 mΩ		≈1.4 Ω	
	Input impedance	≈300 KΩ		≈150 KΩ		≈2 MΩ	
Dimension (W*D*H)		214.5mm*88.2mm*354.6mm		214.5mm*88.2mm*354.6mm		214.5mm*88.2mm*354.6mm	



IT8514B+ / IT8516C+ Specification

		IT8514B+		IT8516C+		
Input Rating	Voltage	0 500 V		0 120 V		
	Current	0 6 A	0 60 A	0 24 A	0 240 A	
(0~40°C)	Power	1500 W		3000 W		
	Minimum operating voltage	0.25 V at 6 A	2.5 V at 60 A	0.15 V at 24 A	1.5V at 240 A	
CV Mode	Range	0.1 50 V	0.1 500 V	0.1 18 V	0.1 120 V	
	Resolution	1 mV	10 mV	1 mV	10 mV	
	Accuracy	(0.05 +0.02 FS)	(0.05 +0.025 FS)	(0.05 +0.02 FS)	(0.05 +0.025 FS)	
CC Mode	Range	0 6 A	0 60 A	0 24 A	0 240 A	
	Resolution	1 mA	10 mA	1 mA	10 mA	
	Accuracy	(0.05 +0.05 FS)	(0.1 +0.1 FS)	(0.1 +0.1 FS)	(0.1 +0.1 FS)	
CR Mode*1	Range	0.05Ω~10Ω	10Ω~7.5 KΩ	0.05Ω~10Ω	10Ω~7.5 KΩ	
	Resolution	16 bit		16 bit		
	Accuracy	0.02 +0.08 S	0.01 +0.0008 S	0.02 +0.08 S	0.02 +0.0008 S	
CP Mode*1	Range	1500 W		3000 W		
	Resolution	10 mW		10 mW		
	Accuracy	(0.2 +0.2 FS)		(0.2 +0.2 FS)		
Dynamic mode						
Dynamic Mode	T1 & T2	100μS~3600 S/ Res:1μS		20μS~3600 S/ Res:1μS		
	Accuracy	10μS+100 ppm		10μS+100 ppm		
	Rising/falling slope *3	0.001~0.15 A/μS	0.01~0.8 A/μS	0.001~0.3 A/μS	0.1~2.8 A/μS	
	Minimum rising time *4	≈60 μS		≈70 μS		
Measurement range						
V Measurement	Range	0 50 V	0 500 V	0 18 V	0 120 V	
	Resolution	0.1 mV	1 mV	0.1 mV	1 mV	
	Accuracy	(0.025 +0.025 FS)				
C Measurement	Range	0 6 A	0 60 A	0 24 A	0 240 A	
	Resolution	1 mA	10 mA	1 mA	10 mA	
	Accuracy	(0.05 +0.05 FS)				
P Measurement	Range	1500W		3000W		
	Resolution	10mW		10mW		
	Accuracy	(0.2 +0.2 FS)				
Protection						
OPP		≈1550W		≈3050W		
OCP		≈ 6.7 A	≈ 67 A	≈ 26 A	≈ 260 A	
OVP		≈530 V		≈125 V		
OTP		≈ 85°C		≈ 85°C		
Specification						
Short Circuit	Current(CC)	≈ 6.7 / 6 A	≈ 67 / 60 A	≈ 26 / 24 A	≈ 260 / 240 A	
	Voltage(CV)	0 V		0 V		
	Resistance(CR)	≈ 30 mΩ		≈ 5 mΩ		
	Input impedance	≈ 150 KΩ		≈ 150 KΩ		
Dimension (W*D*H)		436.5 mm* 88.2 mm*463.5 mm			436.5 mm* 176 mm* 463.5 mm	

*1.Voltage/Current input ≥10%FS (FS means final scal)

*2.Resistance readback value range:1/[1/R+(1/R)*0.01%+0.08],1/[1/R-(1/R)*0.01%-0.08], IT8514B+/14C+/16C+:1/[1/R+(1/R)*0.02%+0.08],1/[1/R-(1/R)*0.02%-0.08]

*3.Rise/fall slope: rise slope of 10%~90% current rising from 0 to maximum value

*4. Minimum rising time:is the 10%~90% current rising time

IT8514B+ / IT8514C+

IT8516C+

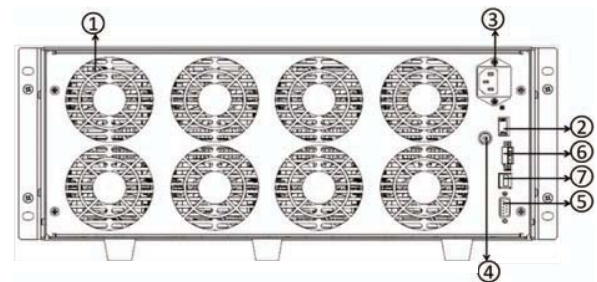
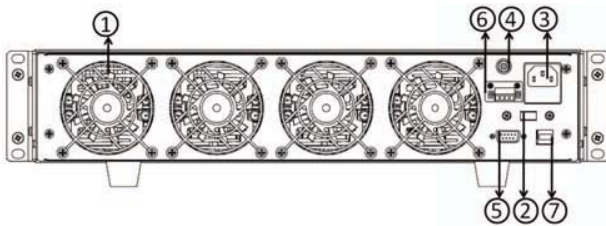

- ① Air vents
- ② Voltage switch (110V/220V)
- ③ AC line input
- ④ Current monitoring terminal
- ⑤ RS232 interface
- ⑥ Trigger and remote sensing terminal block
- ⑦ USB interface

- ① Air vents
- ② Voltage switch (110V/220V)
- ③ AC line input
- ④ Current monitoring terminal
- ⑤ RS232 interface
- ⑥ Trigger and remote sensing terminal block
- ⑦ USB interface