

RIGOL

Quick Guide

English

DS4000E Series Digital Oscilloscope

May 2016
RIGOL TECHNOLOGIES, INC.

Guaranty and Declaration

Copyright

© 2016 **RIGOL** TECHNOLOGIES, INC. All Rights Reserved.

Trademark Information

RIGOL is a registered trademark of **RIGOL** TECHNOLOGIES, INC.

Publication Number

QGA21101-1110

Notices

- **RIGOL** products are covered by P.R.C. and foreign patents, issued and pending.
- **RIGOL** reserves the right to modify or change parts of or all the specifications and pricing policies at the company's sole decision.
- Information in this publication replaces all previously released materials.
- Information in this publication is subject to change without notice.
- **RIGOL** shall not be liable for either incidental or consequential losses in connection with the furnishing, use, or performance of this manual, as well as any information contained.
- Any part of this document is forbidden to be copied, photocopied, or rearranged without prior written approval of **RIGOL**.

Product Certification

RIGOL guarantees that this product conforms to the national and industrial standards in China as well as the ISO9001:2008 standard and the ISO14001:2004 standard. Other international standard conformance certifications are in progress.

Contact Us

If you have any problem or requirement when using our products or this manual, please contact **RIGOL**.

E-mail: service@rigol.com

Website: www.rigol.com

Contents

Guaranty and Declaration	2
Contents	3
General Safety Summary	4
Safety Notices and Symbols.....	4
Care and Cleaning	5
Document Overview	6
General Inspection.....	7
Product Overview	7
To Prepare the Oscilloscope for Use	11
To Remove the Front Panel Cover.....	11
To Connect to Power Supply	11
Power-on Inspection	12
To Connect the Probe.....	12
Function Inspection for the Passive Probe	14
Probe Compensation.....	16
To Use the Built-in Help System	16
Remote Control	18
More Product Information	18

General Safety Summary

1. Only the exclusive power cord designed for the instrument and authorized for use within the local country could be used.
2. Ensure that the instrument is safely grounded.
3. Connect the probe correctly.
4. Observe all terminal ratings.
5. Use proper overvoltage protection.
6. Do not operate without covers.
7. Do not insert objects into the air outlet.
8. Use the proper fuse.
9. Avoid circuit or wire exposure.
10. Do not operate the instrument with suspected failures.
11. Provide adequate ventilation.
12. Do not operate in wet conditions.
13. Do not operate in an explosive atmosphere.
14. Keep instrument surfaces clean and dry.
15. Prevent electrostatic impact.
16. Handle with caution.

Safety Notices and Symbols

Safety Notices in this Manual:



WARNING

Indicates a potentially hazardous situation or practice which, if not avoided, will result in serious injury or death.



CAUTION

Indicates a potentially hazardous situation or practice which, if not avoided, could result in damage to the product or loss of important data.

Safety Terms on the Product:

- DANGER** It calls attention to an operation, if not correctly performed, could result in injury or hazard immediately.
- WARNING** It calls attention to an operation, if not correctly performed, could result in potential injury or hazard.
- CAUTION** It calls attention to an operation, if not correctly performed, could result in damage to the product or other devices connected to the product.

Safety Symbols on the Product:



Hazardous
Voltage



Safety
Warning



Protective Earth
Terminal

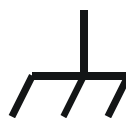

Chassis Ground



Test Ground

Care and Cleaning

Care

Do not store or leave the instrument where it may be exposed to direct sunlight for long periods of time.

Cleaning

Clean the instrument regularly according to its operating conditions.

1. Disconnect the instrument from all power sources.
2. Clean the external surfaces of the instrument with a soft cloth dampened with mild detergent or water. When cleaning the LCD, take care to avoid scarifying it.



CAUTION

To avoid damage to the instrument, do not expose it to caustic liquids.



WARNING

To avoid short-circuit resulting from moisture or personal injuries, ensure that the instrument is completely dry before connecting it to the power supply.

Document Overview

This manual introduces some basic information that you should know when you use the DS4000E series digital oscilloscope for the first time. For more information about this instrument, log in to the **RIGOL** official website (www.rigol.com) to download the latest version of the relevant manuals.

Format Conventions in this Manual

1. Key

The key on the front panel is denoted by the format of "Key Name (Bold) + Text Box" in the manual. For example, **Utility** denotes the "Utility" key.





2. Menu softkey

The menu softkey is denoted by the format of "Menu Name (Bold) + Character Shading" in the manual. For example, **System** denotes the "System" softkey under **Utility**.

3. Operation Procedures:

The next step of the operation is denoted by an arrow "→" in the manual. For example, **Utility** → **System** denotes that first press **Utility**, and then press **System**.

4. Knob

Icon	Knob
HORIZONTAL  SCALE	Horizontal time base knob
HORIZONTAL  POSITION	Horizontal position knob
VERTICAL  SCALE	Channel vertical scale knob
VERTICAL  POSITION	Channel vertical position knob
TRIGGER  LEVEL	Trigger level knob

Content Conventions in this Manual

DS4000E series includes the following models. Unless otherwise specified, this manual takes DS4024E as an example to illustrate the basic information of DS4000E series.

Model	Analog Bandwidth	No. of Analog Channels
DS4024E	200 MHz	4
DS4014E	100 MHz	4

General Inspection

1. Inspect the packaging

If the packaging has been damaged, do not dispose the damaged packaging or cushioning materials until the shipment has been checked for completeness and has passed both electrical and mechanical tests.

The consigner or carrier shall be liable for the damage to the instrument resulting from shipment. **RIGOL** would not be responsible for free maintenance/rework or replacement of the instrument.

2. Inspect the instrument

In case of any mechanical damage, missing parts, or failure in passing the electrical and mechanical tests, contact your **RIGOL** sales representative.

3. Check the accessories

Please check the accessories according to the packing lists. If the accessories are damaged or incomplete, please contact your **RIGOL** sales representative.

Product Overview

Based on the UltraVision technology, DS4000E is a multi-functional digital oscilloscope with high performance. It is easy to use, and its superb technical specifications and multiple functions are perfectly integrated, enabling you to quickly accomplish the tasks, such as test measurement, remote control, etc.

For a brief introduction about the front panel, refer to Figure 1; for the rear panel, refer to Figure 2; and for the user interface, refer to Figure 3. For details about them, refer to the User's Guide of this instrument.

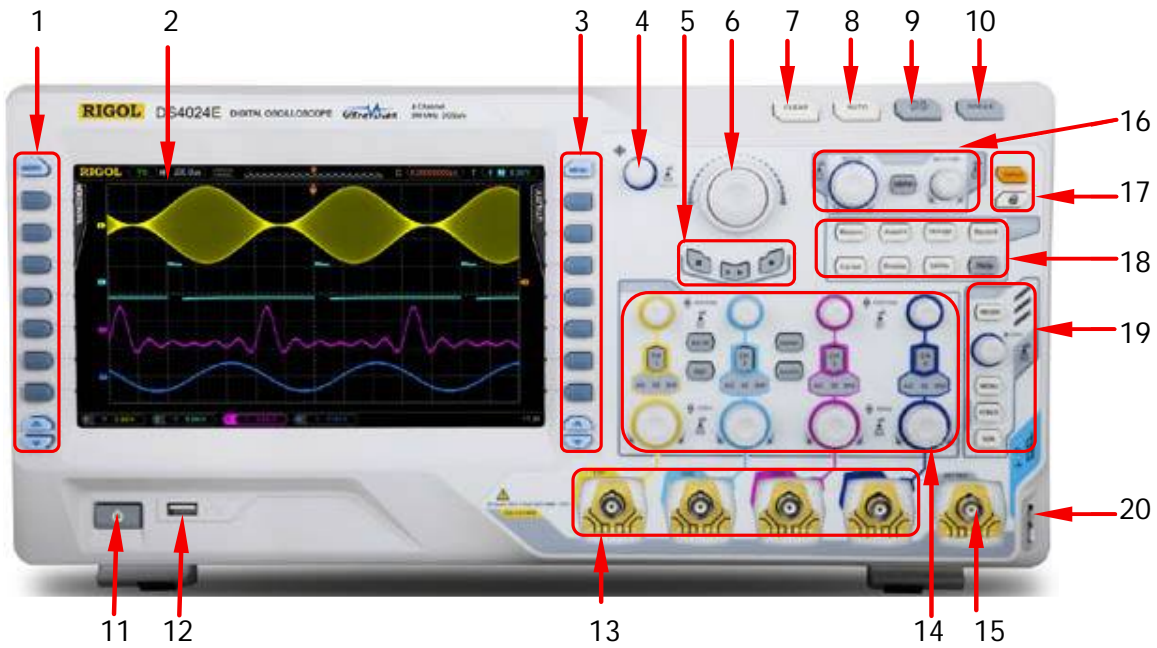

Figure 1 Front Panel

Table 1 Front Panel Description

No.	Description	No.	Description
1	Parameter Measurement Menu Softkeys	11	Power Key
2	LCD	12	USB HOST Interface
3	Function Setting Menu Softkeys	13	Analog Channel Input Terminals
4	Multi-function Knob	14	Vertical Control Area
5	Waveform Record Keys	15	External Trigger Input Terminal
6	Navigation Knob	16	Horizontal Control Area
7	CLEAR Key	17	Default Key and Print Key
8	AUTO Key	18	Function Keys
9	RUN/STOP Key	19	Trigger Control Area
10	SINGLE Key	20	Probe Compensation Signal Output Terminal and Ground Terminal



Figure 2 Rear Panel

Table 2 Front Panel Description

No.	Description
1	Trig Out/Calibration
2	10 MHz In/Out
3	Video Output
4	LAN Interface
5	USB DEVICE Interface
6	USB HOST Interface
7	Lock Hole
8	AC Power Supply Connector and Power Switch

English

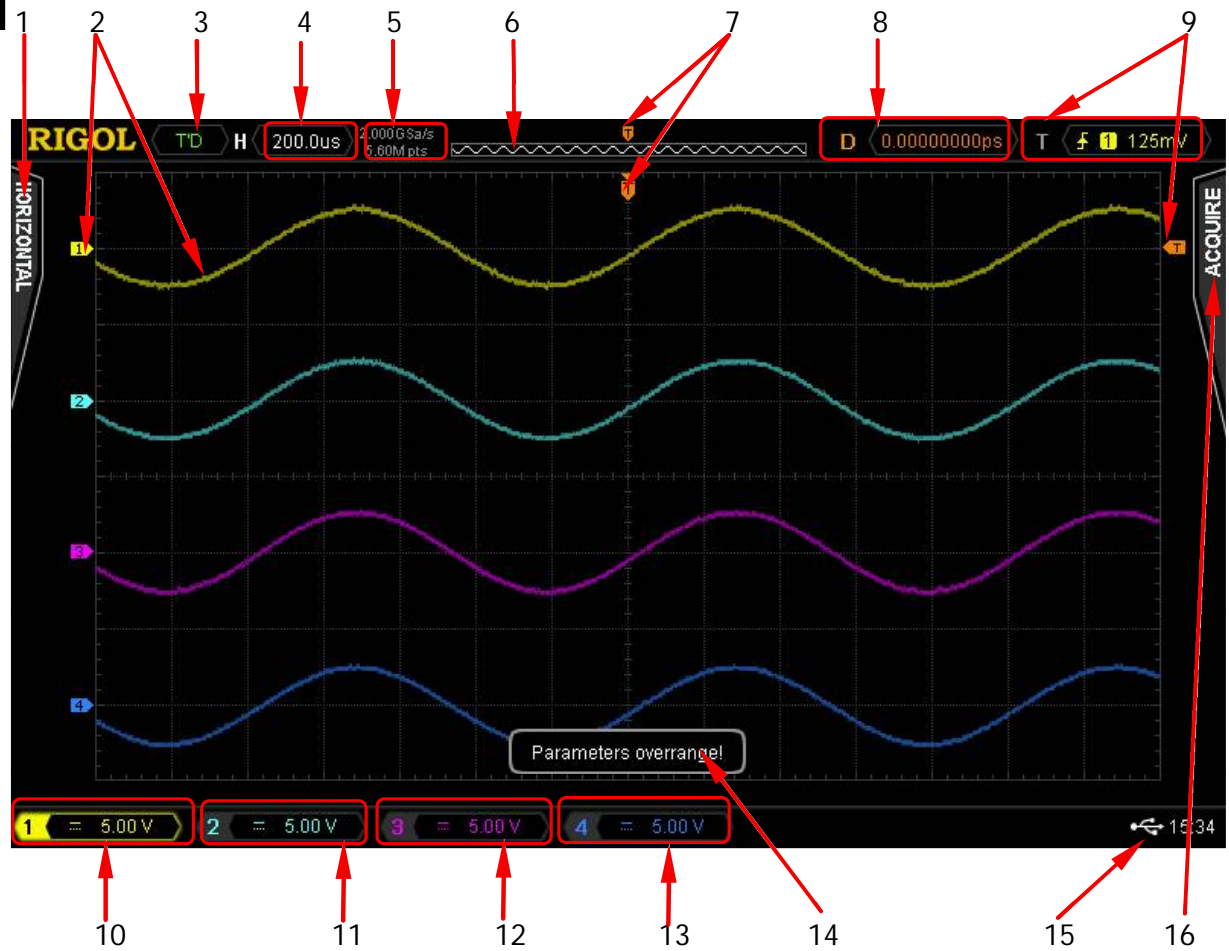

Figure 3 User Interface

Table 3 User Interface Description

No.	Description	No.	Description
1	Auto Measurement Option	9	Trigger Setting
2	Analog Channel Label and Waveform	10	CH1 Status Label
3	Operating Status	11	CH2 Status Label
4	Horizontal Time Base	12	CH3 Status Label
5	Sample Rate and Memory Depth	13	CH4 Status Label
6	Waveform Memory	14	Message Box
7	Trigger Position	15	Notification Area
8	Horizontal Position	16	Function Setting Menu

To Prepare the Oscilloscope for Use

To Remove the Front Panel Cover

Before using the oscilloscope, remove the front panel cover. Grasp the transverse tabs on each side and pull them outward to remove the cover.

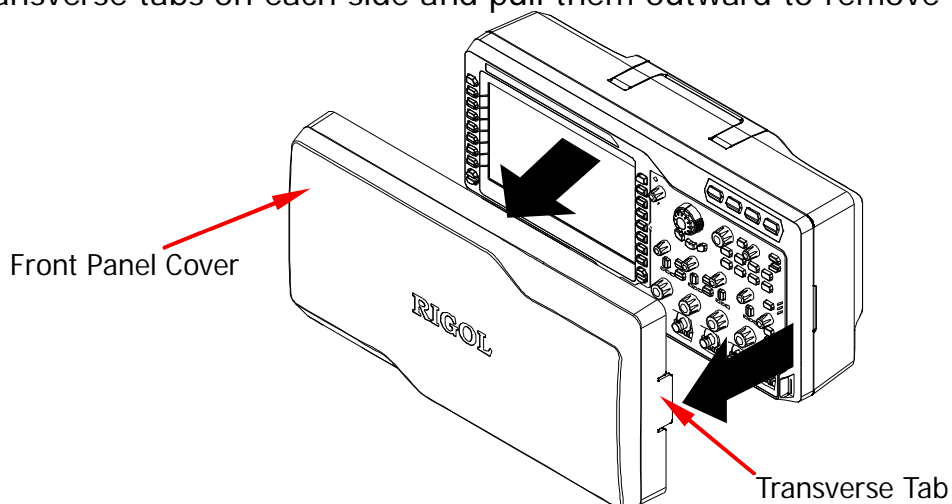



Figure 4 To Remove the Front Panel Cover

To Connect to Power Supply

This oscilloscope supports two kinds of AC input power supplies: 100 V-127 V, 45 Hz-440 Hz; 100 V-240 V, 45 Hz-65 Hz. Please use the power cord supplied with the accessories to connect the oscilloscope to the AC power source, as shown in the figure below. After you turn on the power switch, the oscilloscope is connected to power, and the Power key  located at the lower left corner of the front panel is blinking.

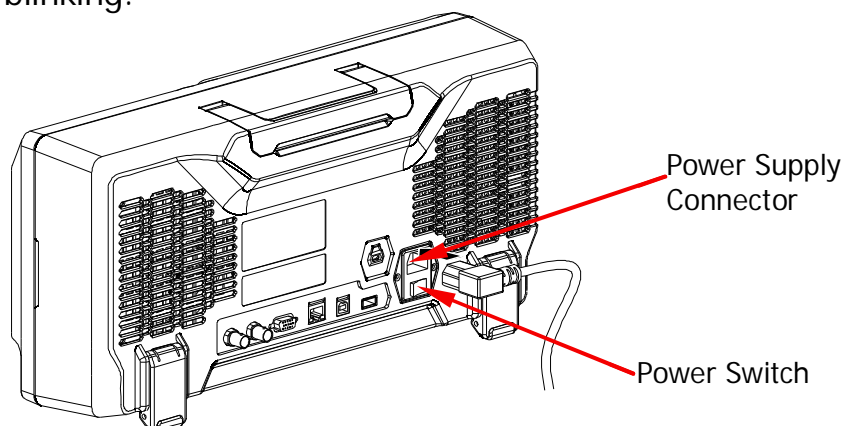



Figure 5 To Connect to Power Supply

Power-on Inspection

When the oscilloscope is connected to power, press the Power key  at the lower left corner of the front panel to start the oscilloscope. During the start-up process, the oscilloscope performs a series of self-tests. You can hear the switching sound of the relay. After the self-test, the welcome screen is displayed. The "Current Options" dialog box will be displayed if your instrument currently has installed the trial versions of the options. From this dialog box, you can view the name, version, and the remaining trial time of the option currently installed. The instrument will be installed with the trial versions of the options before leaving factory. Its remaining trial time is about 2,000 minutes. You can press **Utility** → **System** → **SelfTestInfo** to view the self-test results.

To Connect the Probe

RIGOL provides passive and active probes for DS4000E. For detailed information of the probes, please refer to the User's Guide of the corresponding probe. The following table lists the recommended probes for this oscilloscope.

Model	Description
RP3300A	350 MHz, passive probe, standard, auto detection
RP7150	1.5 GHz, active probe, optional, auto detection

Besides, DS4000E supports Tektronix probes with TekProbe II BNC Interface (required to be used with the option - **RIGOL** T2R1000 interface adapter).

To Connect the Passive Probe

1. Connect the BNC terminal of the probe to an analog channel input terminal or the external trigger input connector on the front panel of the oscilloscope.
2. Connect the ground alligator clip or spring of the probe to the circuit ground terminal and connect the probe tip to the circuit point to be tested.

After connecting the passive probe, you need to perform probe function inspection and probe compensation adjustment before making measurements. For detailed procedures, refer to "**Function Inspection for the Passive Probe**" and "**Probe Compensation**".

To Connect the Active Probe

Take RP7150 (using the differential probe front) as an example.

1. Connect the probe head to the active probe amplifier.

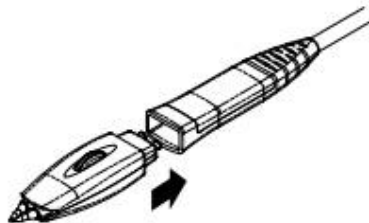

2. Connect the other end of the active probe amplifier to the analog channel input terminal or the external trigger input connector on the front panel of the oscilloscope. Note that you need to push the probe straight on until it latches into place.

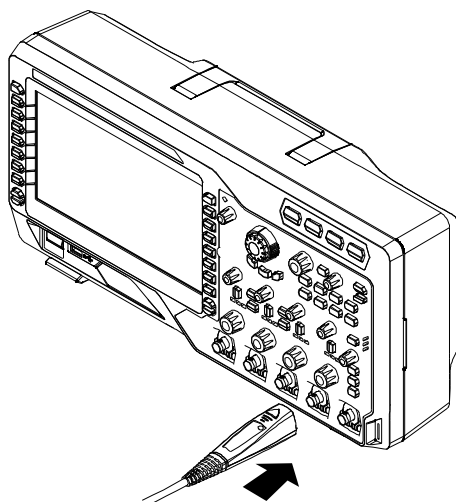

Figure 6 To Connect the Active Probe

3. Use the probing aids to connect the probe head to the circuit under test.

After connecting the active probe, you can perform probe calibration and offset voltage adjustment if necessary. For detailed procedures, refer to the User's Guide of this instrument.

To Connect the Tektronix Probe

1. Connect the Tektronix probe to one end of T2R1000 adapter properly.
2. Connect the other end of T2R1000 adapter to the analog channel input terminal or the external trigger input connector on the front panel of the oscilloscope.



3. Connect the ground terminal of the probe to the circuit ground terminal, and connect the probe tip to the test point of the circuit.

For the specified model of the Tektronix probe, after connecting the probe, you can perform probe calibration and offset voltage adjustment if necessary. For detailed procedures, refer to the User's Guide of this instrument.

Function Inspection for the Passive Probe

You need to perform probe function inspection according to the steps below before making measurements with the passive probe.

1. Press **Default** → **OK** to restore the oscilloscope to factory settings.
2. Connect the ground alligator clip of the probe to the "Ground Terminal" as shown in Figure 7 below.
3. Connect one end of the probe to CH1 input terminal of the oscilloscope, and connect the other end to the "Probe Compensation Signal Output Terminal" as shown in Figure 7.

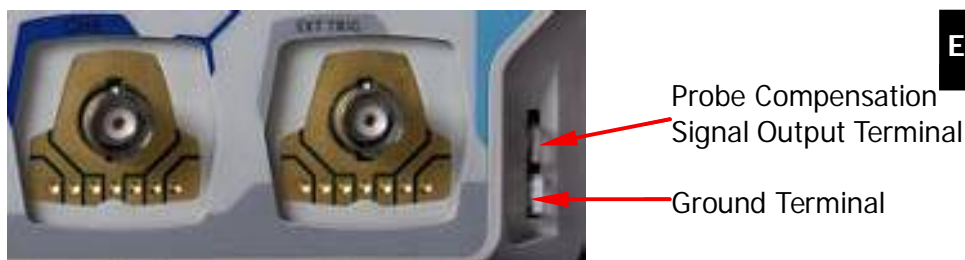

Figure 7 To Use the Compensation Signal

4. Press **AUTO**.
5. Observe the waveform on the screen. In normal conditions, the square waveform is displayed, as shown in the figure below. If the square waveform actually shown does not match that in the figure below, please follow the procedures for "**Probe Compensation**" in the next section.

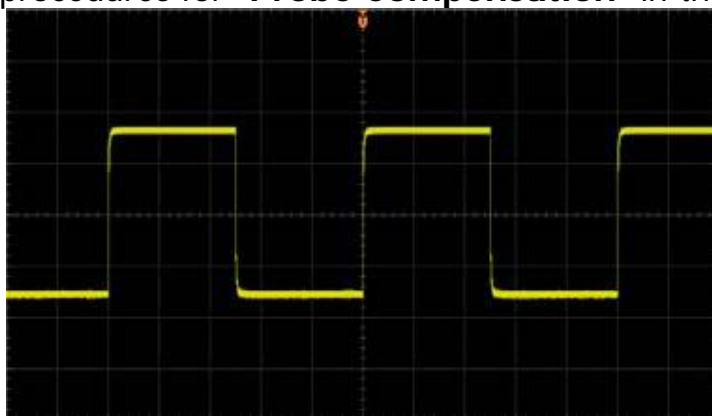

Figure 8 Probe Compensation Signal (Square Waveform)

6. Use the same method to inspect other analog channels.



WARNING

To avoid electric shock, please ensure that the insulated wire of the probe is in good condition, and do not touch the metallic part of the probe when the probe is connected to high voltage source.

Tip

The probe compensation signal can only be used for probe compensation adjustment and cannot be used for calibration.

Probe Compensation

When the probe is used for the first time or when the probe compensation signal does not match that shown in Figure 8, you should compensate the probe to match the input channel of the oscilloscope. The non-compensated or poorly compensated probe may cause measurement errors.

The procedures for the probe compensation are as follows:

1. Perform Step 1, 2, 3, and 4 in the above section.
2. Check the waveform displayed on the screen of the oscilloscope and compare it with the waveforms shown in the figure below.

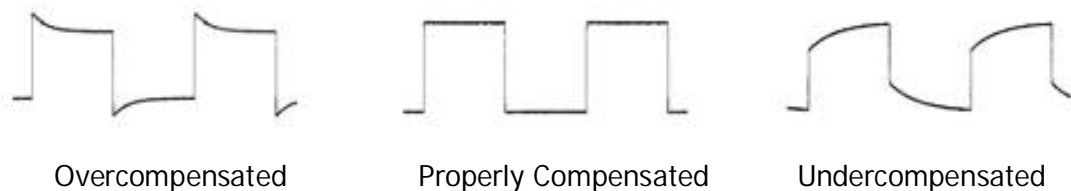

Figure 9 Probe Compensation

3. Use a nonmetallic screwdriver to adjust the low-frequency compensation adjustment hole on the probe until the waveform is displayed as "Properly Compensated" in the figure above.

To Use the Built-in Help System

The help system of this oscilloscope provides instructions for all the function keys and menu softkeys on the front panel. Press **Help** to open the help interface, and press it again to close the interface. The help interface consists of two sections. The left section is "Help Options", and you can select the "Button" or "Index" tab. The right section is "Help Display Area", which displays the help information.

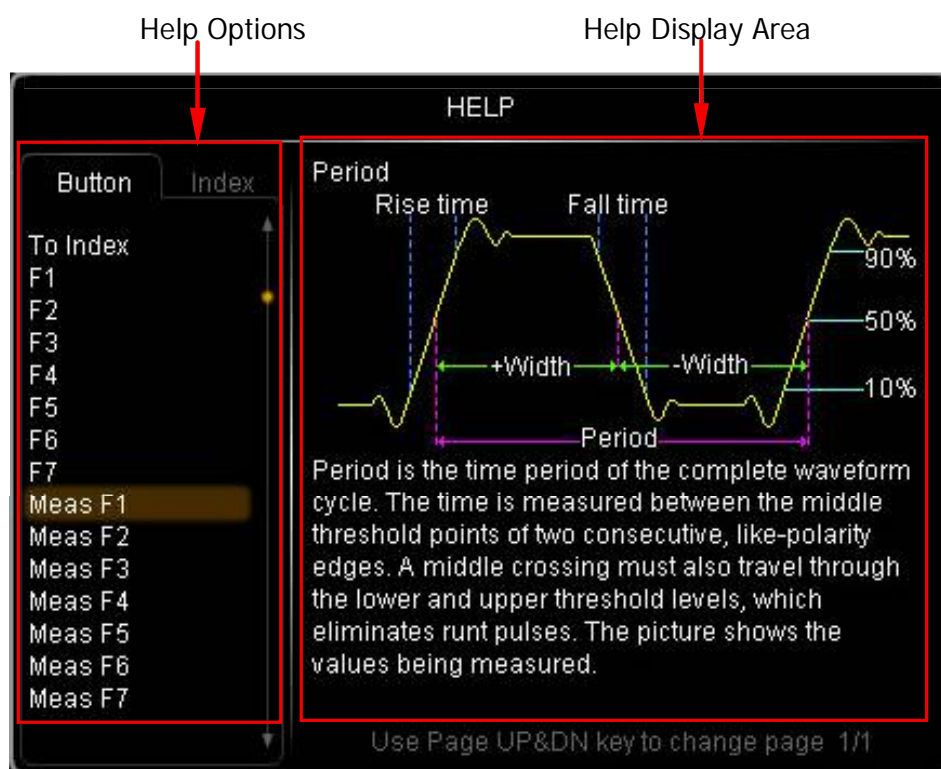









Figure 10 Help Information

Button:

By default, the "Button" tab is selected. Under the tab, you can view the corresponding help information in the "Help Display Area" by pressing the keys or menu softkeys (except the Power key , multi-function knob , and the Page Up/Down key ) on the front panel directly or rotating the multi-function knob  to select the desired key name (the item currently selected is displayed with brown shading) in the "Help Options" area and then pressing down the knob.

Besides, you can acquire the help information of the navigation knob by rotating the multi-function knob  to select "WaveSearch" or directly rotating the navigation knob to quickly select "WaveSearch". To switch to the "Index" tab, use the multi-function knob  to select "To Index" and then press down the knob.

Index:

Under the tab, you can view the corresponding help information in the "Help Display Area" by rotating the multi-function knob  to select the desired key name (the item currently selected is displayed with brown shading) in the "Help Options" area and then pressing down the knob. To switch to the **Button** tab, use the multi-function knob  to select "To Button" and then press down the knob.

Remote Control

DS4000E series digital oscilloscope can be connected to the PC via the USB, LAN, or GPIB (option) interface to set up communication and realize remote control through the PC. The remote control can be realized by using SCPI (Standard Commands for Programmable Instruments) commands. DS4000E series digital oscilloscope supports two ways of remote control: user-defined programming and PC software (e.g. **RIGOL** Ultra Sigma).

More Product Information

1. Obtain the device information

Press **Utility** → **System** → **System Info** to obtain the information of the instrument, including the manufacturer, model, serial number, as well as software and hardware version number.

2. Check the option installation status

Press **Utility** → **Options** → **Installed** to view the installation status of the current option.

For more information about this instrument, refer to the relevant manuals by logging in to the official website of **RIGOL** (www.rigol.com) to download them.

DS4000E User's Guide

introduces the functions of the instrument and the operation methods, remote control methods, possible failures and solutions in using the DS4000E series, specifications, and order information;

DS4000E Programming Guide

provides detailed descriptions of SCPI commands and programming instances of the instrument.

DS4000E Datasheet

provides the main features and technical specifications of the instrument.